



EXISTING SWITCH AND WIRE IDENTIFICATION WITH CORRESPONDING DCI REPLACEMENT WIRES

VIEWED FROM FRONT OF CHAIR

WHITE TOGGLE SWITCH

BLACK TOGGLE SWITCH

GRAY TOGGLE SWITCH

L
E
F
T

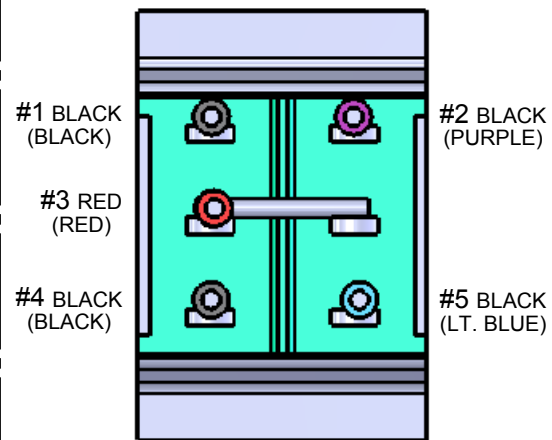
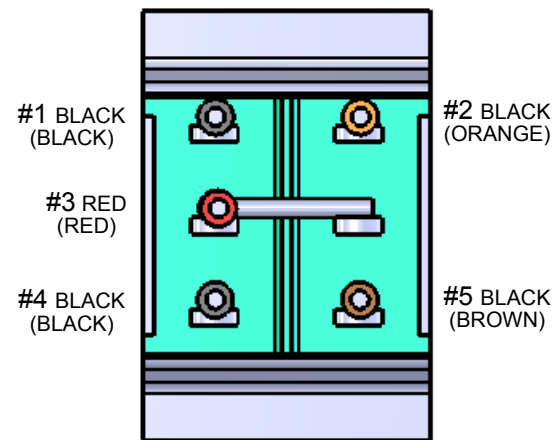
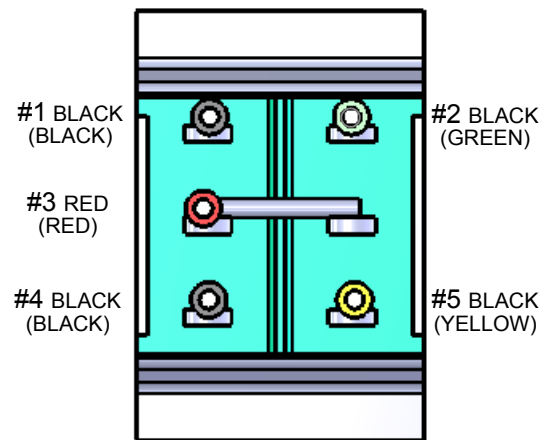

R
I
G
H
T

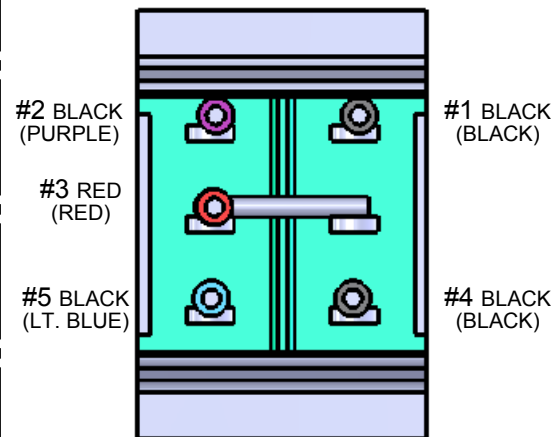
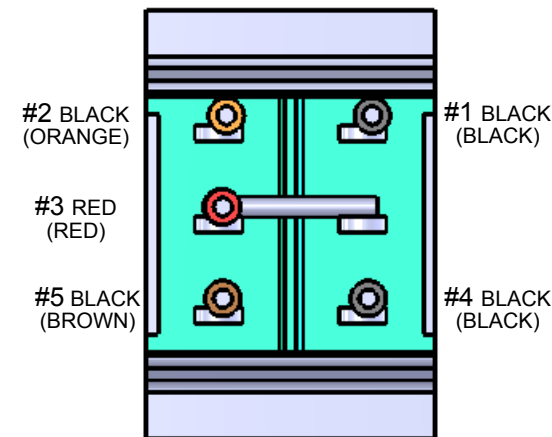
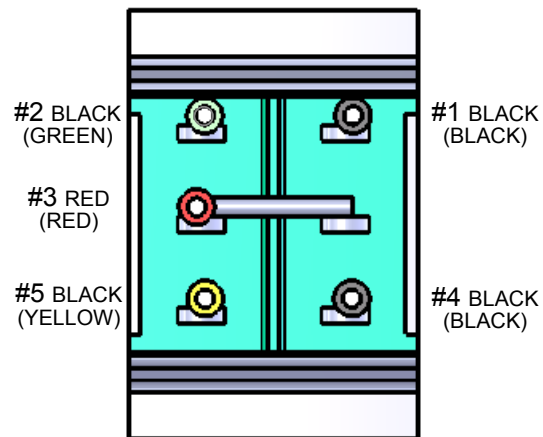

DCI REPLACEMENT SWITCH

9247 WHITE TOGGLE DCI SWITCH

9248 BLACK TOGGLE DCI SWITCH

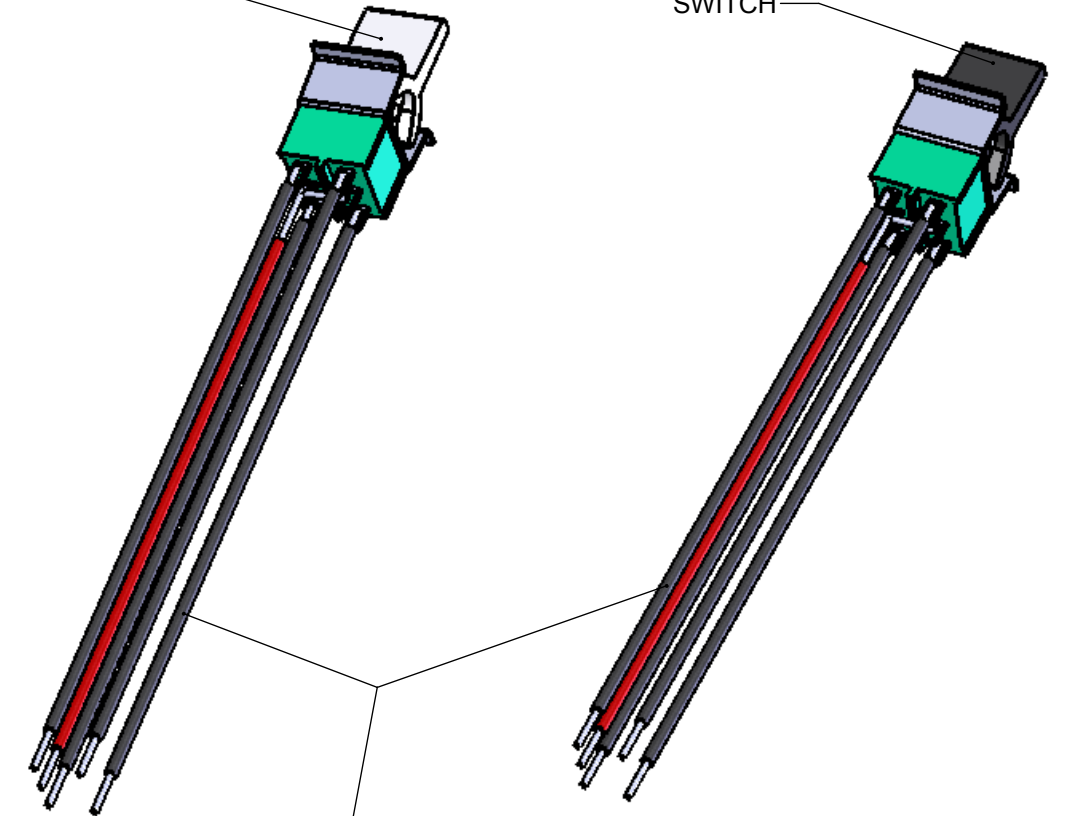

DCI REPLACEMENT SWITCH WIRES ARE IDENTIFIED WITH #1-5.

DCI BLACK REPLACEMENT TOGGLE USED FOR BOTH BLACK AND GRAY SWITCHES

REPLACEMENT STEPS:

1. DISCONNECT POWER FROM CHAIR.
2. REMOVE CHAIR CONTROL PANEL.
3. LOCATE SWITCH AND REMOVE FROM CONTROL PANEL.
4. IDENTIFY COLOR OF TOGGLE SWITCH TO BE REPLACED - SEE ABOVE FOR REFERENCE.
5. IDENTIFY COLOR SEQUENCE OF WIRE ON SWITCH BEING REPLACED.
6. CUT WIRES FROM OLD SWITCH - LEAVING SMALL AMOUNT OF WIRE INSULATION ON SWITCH FOR REFERENCE.
7. CHAIR WIRING - STRIP 1/2" OF INSULATION FROM EXISTING WIRES.
8. DCI REPLACEMENT SWITCH - USE APPROPRIATE NUMBERED REPLACEMENT WIRES ACCORDING TO NUMBERED AREA ABOVE RELATED TO EXISTING WIRE COLORS LISTED IN PARENTHESES.
9. TWIST TOGETHER CORRECTLY NUMBERED DCI REPLACEMENT SWITCH WIRES WITH EXISTING CHAIR WIRING AND CONNECT WITH SUPPLIED WIRE NUTS.
10. INSTALL SWITCH INTO CONTROL PANEL AND REATTACH CONTROL PANEL TO CHAIR.
11. RECONNECT POWER TO CHAIR.